

<本体>

平面図

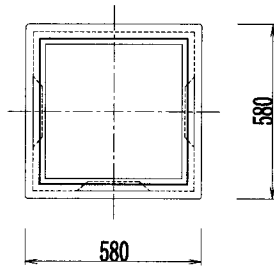

側面図

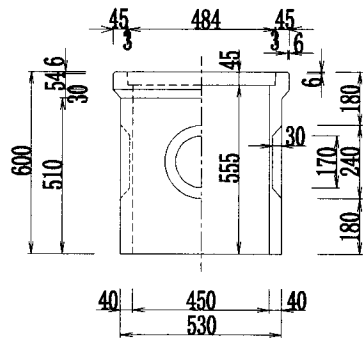

<継ぎ材>

平面図

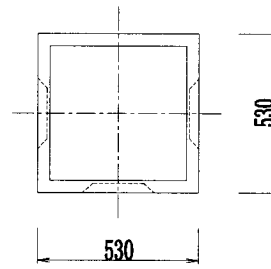

側面図

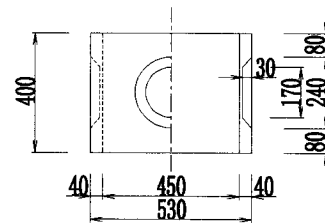

<ふた>

平面図

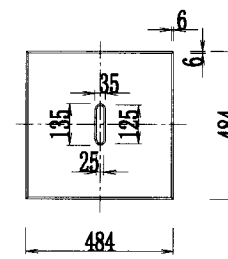

側面図

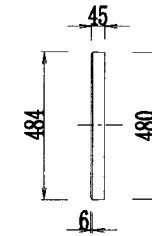

側面図

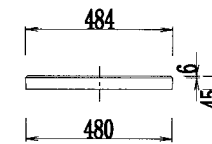

呼び名	集水桝 450 寸法図
規格	450×600 (B×h)
縮尺	S=1/25
会社名	松川・モルセラ株式会社